



Mini Hi-Fi System



Let's make things better.



PHILIPS



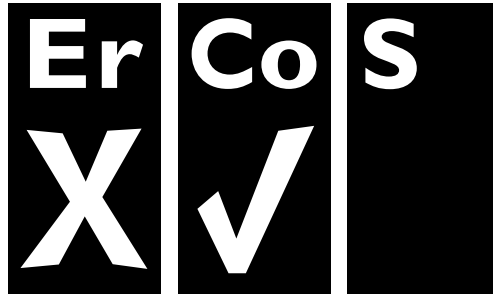

**Optimum disc playability :
ensuring excellent picture quality**

Philips components and modules for the various CD applications have always enjoyed an excellent reputation in the market place for super disc playability - the ability to play discs which may be scratched, soiled or not fully according to the standard specification. This position has been underlined by tests showing the superior performance of the various Philips players, as well as by the positive experiences of millions of individual consumers around the world.

Constantly improving performance

As the penetration in the CD system has increased, and new applications like CD-ROM and Video CD have become commonplace, Philips Components - as the CD technology inventor and as one of the major suppliers of CD player modules in the industry - has constantly improved the performance of its products.

One of the ways in which this benefits users is by optimum disc playability. This is an important parameter for CD players other than CD Audio, and especially for the Video CD applications, because any loss of data from the disc will at best cause disturbances in the reproduced picture, and at worst can cause the player to lose track so that disc playing fails.

Presenting Super Error Correction

To ensure consistently good results when playing Video CD discs of all quality grades and conditions, Philips has introduced further improvements in the system's playability. These developments together are called Super Error Correction, a proprietary Philips technology optimizing the system's ability to handle less-than-perfect discs with the minimum disturbance to normal playing.

By effectively eliminating virtually all errors arising under normal playing conditions, Super Error Correction ensures that the picture quality as seen by the user is independent of disc play. The video encoding and processing during mastering of the disc, and the MPEG-1 decoding and video encoding in the signal processing stages, are now the only limiting factors for picture quality.

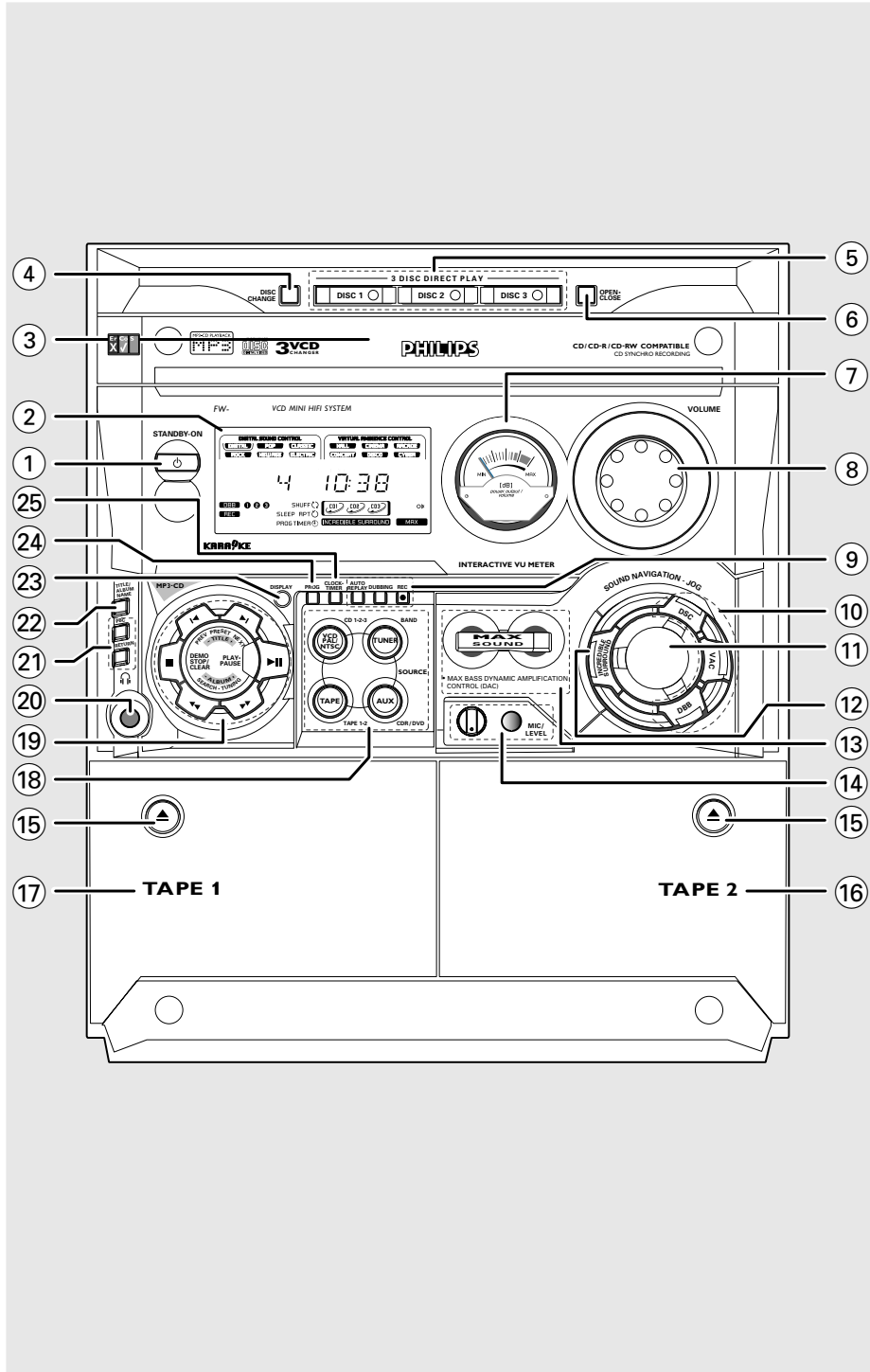



DEMO MODE

To turn ON

Press & HOLD



button

for 5 seconds

To turn OFF

Press & HOLD



button

for 5 seconds

PLUG & PLAY

1



Plug in the unit

2



Follow instructions
in the display

3



Press "PLAY"



Index

English 6

中文 33

Bahasa Melayu 61

Bahasa Indonesia 89

English

中文

Bahasa Melayu

Bahasa Indonesia



CAUTION

Use of controls or adjustments or performance of procedures other than herein may result in hazardous radiation exposure or other unsafe operation.





English

Contents

General Information

Environmental Information	7
Supplied Accessories	7
Safety Information	7

Preparations

Rear Connections	8–9
Inserting batteries into the remote control	9

Controls

Controls on the system and remote control	10–12
---	-------

Basic Functions

Plug and Play	13
Demonstration mode	13
Switching the system on	14
Switching the system to Standby mode	14
Power Saving Automatic Standby	14
Display mode	14
Volume Control	14
Sound Navigation	15

CD/VCD/MP3-CD Operation

Discs for Playback	16
Loading Discs	17
Disc Playback	17
Replace discs during playback	17
Select a desired track/passage	18
Programming the disc tracks	18–19
Repeat	19
Title/Album Name	19

VIDEO CD

Adjusting the TV System	20
OSD – On Screen Display	20
Playing a Video CD with PBC	20
Return	21
Digest	21
A-B Repeat	21
Zoom	21
Resume	22
Slow	22
Vocal	22
Key Control	22
Echo	22

Radio Reception

Storing Preset Radio Stations	23–24
Tuning to Preset Radio Stations	24
Erasing a Preset Radio Station	24
Changing Tuning Grid	24

Tape Operation/Recording

Tape Playback	25
General Information on Recording	26
Preparation for Recording	26
One Touch Recording/Recording the mixed sound	26
CD/VCD/MP3-CD Synchro Recording	26–27
Dubbing Tapes	27

Karaoke

Microphone Mixing	27
-------------------------	----

Clock/Timer

View Clock	28
Clock Setting	28
Timer Setting	28–29

External Sources

Listening to External Sources	29
-------------------------------------	----

Specifications

Maintenance

Troubleshooting



General Information

IMPORTANT!
PLEASE NOTE THAT THE VOLTAGE SELECTOR LOCATED AT THE REAR OF THIS SYSTEM IS PRESET AT 220V FROM THE FACTORY. FOR COUNTRIES THAT OPERATE AT 110V-127V, PLEASE ADJUST TO 110V-127V BEFORE YOU SWITCH ON THE SYSTEM.

Environmental Information

All unnecessary packaging has been omitted. We have tried to make the packaging easy to separate into three materials: cardboard (box), polystyrene foam (buffer) and polyethylene (bags, protective foam sheet).

Your system consists of materials which can be recycled and reused if disassembled by a specialised company. Please observe the local regulations regarding the disposal of packaging materials, exhausted batteries and old equipment.

Supplied accessories

- Remote control
- Batteries (two AA size) for remote control
- AM loop antenna
- FM wire antenna
- AC power cord
- One Video cinch cable

Safety Information

- Before operating the system, check that the operating voltage indicated on the typeplate (or the voltage indication beside the voltage selector) of your system is identical with the voltage of your local power supply. If not, please consult your dealer.
- Place the system on a flat, hard and stable surface.
- Place the system in a location with adequate ventilation to prevent internal heat build-up in your system. Allow at least 10 cm (4 inches) clearance from the rear and the top of the unit and 5 cm (2 inches) from each side.
- Do not expose the system, batteries or discs to excessive moisture, rain, sand or heat sources caused by heating equipment or direct sunlight.
- If the system is brought directly from a cold to a warm location, or is placed in a very damp room, moisture may condense on the lens of the disc unit inside the system. Should this occur; the CD player would not operate normally. Leave the power on for about one hour with no disc in the system until normal playback is possible.
- The mechanical parts of the set contain self-lubricating bearings and must not be oiled or lubricated.
- **When the system is switched to Standby mode, it is still consuming some power. To disconnect the system from the power supply completely, remove the AC power plug from the wall socket.**



Preparations

English

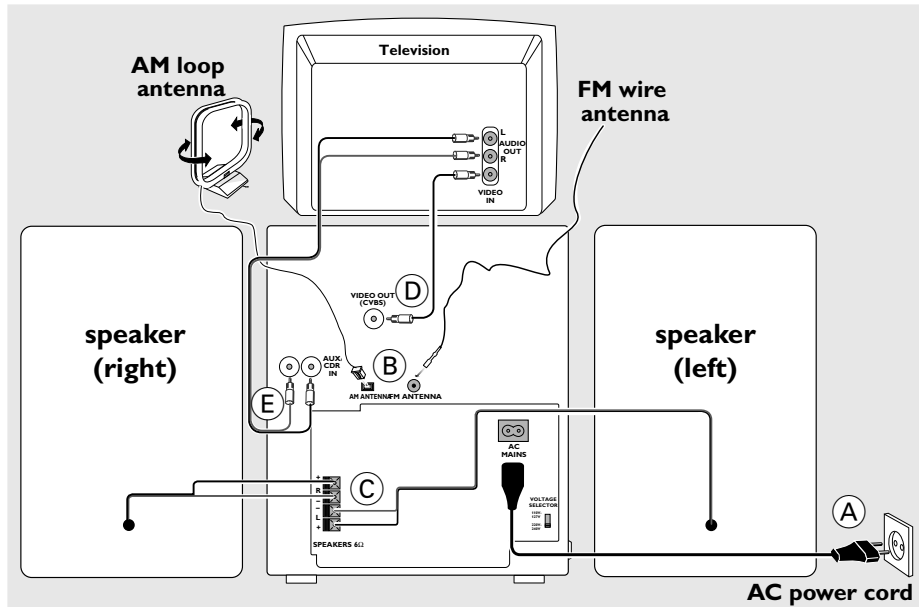

Rear Connections

The type plate is located at the rear of the system.

A Power

Before connecting the AC power cord to the wall outlet, ensure that the following are done:

- If your system is equipped with a Voltage Selector, set the VOLTAGE SELECTOR to the local power line voltage.



- All other connections have been made.

WARNING!

- For optimal performance, use only the original power cable.
- Never make or change any connections with the power switched on.

To avoid overheating of the system, a safety circuit has been built in. Therefore, your system may switch to Standby mode automatically under extreme conditions. If this happens, let the system cool down before reusing it (not available for all versions).

B Antennas Connection

Connect the supplied AM loop antenna and FM antenna to the respective terminals. Adjust the position of the antenna for optimal reception.

AM Antenna

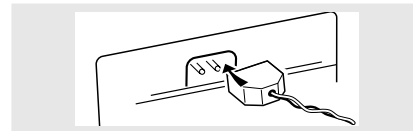

- Position the antenna as far as possible from a TV, VCR or other radiation source.

FM Antenna

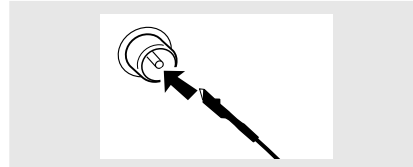

- For better FM stereo reception, connect an outdoor FM antenna to the FM ANTENNA terminal.



Preparations

C Speakers Connection

Front Speakers

Connect the speaker wires to the SPEAKERS (FRONT) terminals, right speaker to "R" and left speaker to "L", coloured (marked) wire to "+" and black (unmarked) wire to "-".

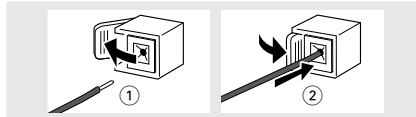

- Fully insert the stripped portion of the speaker wire into the terminal as shown.

Notes:

- For optimal sound performance, use the supplied speakers.
- Do not connect more than one speaker to any one pair of + / - speaker terminals.
- Do not connect speakers with an impedance lower than the speakers supplied. Please refer to the SPECIFICATIONS section of this manual.

D Video Out Connection

Connect the **VIDEO OUT (CVBS)** terminal at the rear of the system to the TV or VCR VIDEO IN for viewing or recording.

Note:

- To avoid magnetic interference with the picture on your TV, do not position the front speakers too close to the TV.

E Connecting other equipment to your system

Connect the audio left and right OUT terminals of a TV, VCR, Laser Disc player, DVD player or CD Recorder to the **AUX/CDR IN** terminals.

Note:

- If you are connecting equipment with a mono output (a single audio out terminal), connect it to the AUX/CDR IN left terminal. Alternatively, you can use a "single to double" cinch cable (still be mono sound).

Inserting batteries into the Remote Control

Insert two batteries (Type R06 or AA) into the remote control with the correct polarity as indicated by the + and - symbols inside the battery compartment.

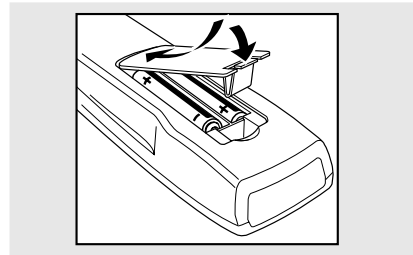

CAUTION!

- Remove batteries if they are exhausted or not to be used for a long time.
- Do not use old and new or different types of batteries in combination.
- Batteries contain chemical substances, so they should be disposed off properly.

English





Controls (main system's illustration on page 3)

English

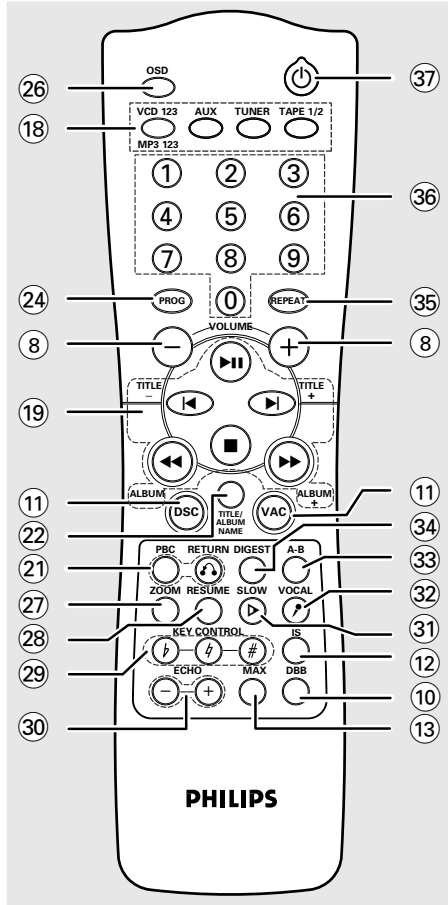

Controls on the system and remote control

- ① **STANDBY ON**
 - to switch the system on or to Standby mode.
- ② **DISPLAY SCREEN**
 - to view the current status of the system.
- ③ **DISC TRAYS**
- ④ **DISC CHANGE**
 - to change disc(s).
- ⑤ **DISC 1 / DISC 2 / DISC 3**
 - to select a disc tray for playback.
- ⑥ **OPEN•CLOSE**
 - to open or close the disc tray.
- ⑦ **INTERACTIVE VU METER**
 - to show the VU (volume unit) meter in music or volume mode depending on the display mode selected.
- ⑧ **VOLUME**
 - to increase or decrease the volume.
- ⑨ **Tape Deck Operation**
- AUTO REPLAY**
 - to select continuous playback in either AUTO PLAY or ONCE mode only.
- DUBBING**
 - to dub a tape.
- REC**
 - to start recording on tape deck 2.
- ⑩ **SOUND NAVIGATION**
 - to select the desired sound feature : DSC, VAC, or DBB.
- ⑪ **JOG CONTROL**
 - to select the desired sound effect for the selected sound feature.
 - DSC DIGITAL, ROCK, POP, NEWAGE, CLASSIC or ELECTRIC.
 - VAC HALL, CONCERT, CINEMA, DISCO, ARCADE or CYBER.
 - DBB BEAT, PUNCH or BLAST.
- ⑫ **INCREDIBLE SURROUND (IS)**
 - to activate or deactivate the surround sound effect.
- ⑬ **MAX SOUND (MAX)**
 - to activate or deactivate the optimal mix of various sound features.

Notes for remote control:

- First, select the source you wish to control by pressing one of the source select keys on the remote control (VCD 123 or TUNER, for example).
- Then select the desired function (▶, ◀, ▶|, for example).



Controls

14 MIC/LEVEL

- to connect microphone jack.
- to adjust the mixing level for karaoke or microphone recording.

15 ▲

- to open the tape deck door.

16 TAPE DECK 2

17 TAPE DECK 1

- 18 **SOURCE** – to select the following:

VCD PAL/NTSC / (CD 1•2•3)

- to select disc tray 1, 2 or 3 (this system can playback normal CD/VCD/MP3-CD format disc).
- (on the system only) to select corresponding video output for NTSC or PAL system of your TV set (except Multi-system TV).

TUNER / (BAND)

- to select waveband : FM or MW.

TAPE / (TAPE 1•2)

- to select tape deck 1 or 2.

AUX / (CDR/DVD)

- to select a connected external source : CDR/DVD or AUX (auxiliary) mode.

19 Mode Selection

PLAY PAUSE ►II

for CD/VCD/MP3-CD...to start or interrupt playback.

for TAPE to start playback.

for PLUG & PLAY...(on the system only) to initiate and start plug & play mode.

SEARCH•TUNING ◀◀▶▶

(ALBUM -/+)

for MP3-CD only...to select previous/next Album

for VCD only...to move the zoomed picture to the left or right.

for CD/VCD to search backward/forward.

for TUNER to tune to a lower or higher radio frequency.

for TAPE to rewind or fast forward.

for CLOCK (on the system only) to set the hour.

DEMO STOP/CLEAR ■

for CD/VCD/MP3-CD...to stop playback or to clear a programme.

for TUNER (on the system only) to stop programming.

..... (on the system only) to delete the preset radio station.

for TAPE to stop playback or recording.

..... to reset tape counter number.

for DEMO (on the system only) to activate/deactivate the demonstration.

for CLOCK (on the system only) to exit clock setting or cancel timer.

for PLUG & PLAY...(on the system only) to exit plug & play mode.

PREV / PRESET / NEXT ◀ ▶

(TITLE -/+)

for MP3-CD only...to select previous/next Title.

for VCD only...to move the zoomed picture down or up.

..... to select next or previous MENU or VCD track during playback (for VCD with PBC switched on).

for CD/VCD to skip to the previous or next track.

for TUNER to select a preset radio station.

for CLOCK (on the system only) to set the minute.

20 🎧

- to connect headphones.

21 VCD Operation (for VCD version 2.0 only)

PBC (PLAYBACK CONTROL)

- to switch on or off PBC mode.

RETURN 🎧

- to return to the previous MENU level during playback (for VCD with PBC switched on).

22 TITLE/ALBUM NAME

- to display the title or album name for MP3-CD.

23 DISPLAY

- to select different screen display mode : NORMAL, MODE 1, MODE 2, or MODE 3.

24 PROG

for CD/VCD/MP3-CD... to programme disc tracks.

for TUNER to programme preset radio stations.

for CLOCK (on the system only) to select 12- or 24-hour clock mode.





Controls

25 CLOCK•TIMER

- to view the clock, set the clock or set the timer.

26 OSD (ON SCREEN DISPLAY)

- to switch on or off the on screen display on the TV.

27 ZOOM

- to enlarge a still picture of the VCD on the TV screen.

28 RESUME

- to continue playback again from where you have stopped (for VCD with PBC switched off).

29 KEY CONTROL (b h #)

- to change the VCD key tone level to suit your vocal range.

b to decrease the key tone level.

h to restore the key tone level to original setting.

..... to increase the key tone level.

30 ECHO - / +

- to adjust the VCD echo level for karaoke after inserted the microphone.

31 SLOW ▶

- to watch the VCD at a slower speed.

32 VOCAL ♪

- to fade out the original vocal from a Karaoke VCD or to switch between mono or stereo mode during audio disc playback.

33 A - B

- to playback a certain scene or passage of a CD/ VCD repeatedly.

34 DIGEST

- to scan through a VCD or a specific track.

35 REPEAT

- to playback track/disc/programme repeatedly.

36 DIGIT 0 - 9

(numbers consisting more than two figures must be keyed in within 2 seconds.)

- to select a track number for CD/VCD/MP3-CD.

37 ⏻

- to switch the system to Standby mode.



Basic Functions

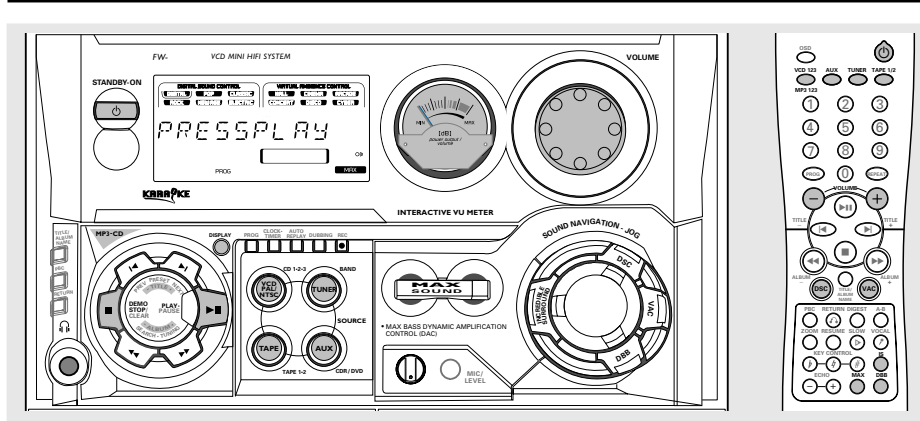

English

IMPORTANT!
Before you operate the system, complete the preparation procedures.

Plug and Play

Plug and Play allows you to store all available radio stations automatically.

If Plug and Play has not been installed

- 1 When you turn on the system, "AUTO INSTALL - PRESS PLAY" will be displayed.
- 2 Press **PLAY ►►** on the system to start installation.
 - "INSTALL" will be displayed and followed by "TUNER" and then "AUTO".
 - **PROG** will start flashing.
 - The system will search for all radio stations on the FM band, then the MW band.
 - All available radio stations with strong signal strength will be stored automatically.
 - The system will stop searching when all the available radio stations are stored or when the memory for 40 preset radio stations is used.
 - The last preset radio station will play when Plug and Play is completed.

To reinstall Plug and Play

- 1 In Standby or Demonstration mode, press and hold **PLAY ►►** on the system until "AUTO INSTALL - PRESS PLAY" is displayed.
- 2 Press **PLAY ►►** again to start installation.
 - All previously stored radio stations will be replaced.

To exit without storing the Plug and Play

- Press **■** on the system.

Notes:

- When the power is turned on, the disc tray may open and close to initialise the system.
- If you do not complete Plug and Play installation, Plug and Play will be reinitiated the next time you turn on the power.
- If no stereo frequency is detected during Plug and Play, "CHECK ANTENNA" will be displayed.
- During Plug and Play, if no button is pressed within 15 seconds, the system will exit Plug and Play mode automatically.

Demonstration mode

The system has a demonstration mode that shows the various features offered by the system.

To activate the demonstration

- In Standby mode, press and hold **DEMO STOP ■** on the system until "DEMO ON" is displayed.
 - The demonstration will begin.

To deactivate the demonstration

- Press and hold **DEMO STOP ■** on the system until "DEMO OFF" is displayed.
 - The system will switch to Standby mode.

Note:

- Even if you remove the AC power cord and reconnect it to the wall socket, the demonstration will remain off until you activate it again.



Basic Functions

Switching the system on

In Standby/Demonstration mode

- Press **STANDBY ON**.
→ The system will switch to the last selected source.
- Press **VCD, TUNER, TAPE, AUX** (or **VCD 123/MP3 123, TUNER, TAPE 1/2** or **AUX** on the remote control).
→ The system will switch to the selected source.
- Press any one of the **DISC DIRECT PLAY** buttons.
→ The system will switch to CD mode.

Switching the system to Standby mode

In Demonstration mode

- Press and hold **DEMO STOP** ■ on the system.

In any other source mode

- Press **STANDBY ON** (or  on the remote control).
→ The clock will appear on the display when the system is in Standby mode.

Note:

– If you have not deactivated the demonstration, it will resume five seconds after the system switches to Standby mode.

Power Saving Automatic Standby

As a power-saving feature, the system will automatically switch to Standby mode if you do not press any buttons within 30 minutes after a disc or tape has stopped playing.

Display mode

There are four different display modes for selection.

- Press **DISPLAY** repeatedly to select **NORMAL**, **MODE 1**, **MODE 2**, or **MODE 3**.

NORMAL All available LEDs will light up and the display screen will have full brightness. The VU meter will be in music mode.

MODE 1 All available LEDs will light up and the display screen will have full brightness. The VU meter will be in volume mode.

MODE 2 All available LEDs will light up and the display screen will be at half brightness. The VU meter will be in music mode.

MODE 3 The display screen will be at half brightness. The VU meter and all LEDs will be off.

Volume Control

Adjust **VOLUME** to increase (turn knob clockwise or press **VOLUME +**) or decrease (turn knob anti-clockwise or press **VOLUME -**) the sound level.

To listen through the headphones

- Connect the headphones plug to the  socket at the front of the system.
→ The speakers will be muted.

Sound Navigation

For optimal sound listening, select only one of the following navigation sound controls at a time : MAX sound, DSC or VAC.

MAX Sound

MAX sound provides the best mixture of various sound features (DSC, VAC, DBB for example).

- Press **MAX SOUND** (or **MAX ON/OFF** on the  repeatedly to activate/deactivate the optimal sound.
→ If activated,  will appear on the display and the MAX SOUND button lights up.
→ If deactivated, "11R: OFF" will be displayed.

Note:

– When MAX sound is selected, all other sound navigation will switch off automatically.



Basic Functions

DSC (Digital Sound Control)

The DSC feature enables you to adjust the system to suit your type of music.

- 1 Press **DSC**.
→ DSC button lights up
- 2 Adjust the **JOG CONTROL** (or press **DSC** on the remote control repeatedly) to select the desired Digital Sound Control effect : DIGITAL, ROCK, POP, NEWAGE, CLASSIC or ELECTRIC.
→ The selected DSC will be highlighted.

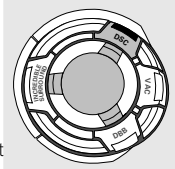

Note:

– For a neutral sound effect, select **CLASSIC**.

VAC (Virtual Ambience Control)

The VAC feature enables you to adjust the system to select a type of environment.

- 1 Press **VAC**.
→ VAC button lights up.
- 2 Adjust the **JOG CONTROL** (or press **VAC** on the remote control repeatedly) to select the desired Virtual Ambience Control effect : HALL, CONCERT, CINEMA, DISCO, ARCADE or CYBER.
→ The selected VAC will be highlighted.

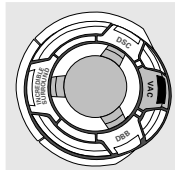

Note:

– When you select **VAC**, **Incredible Surround** will switch on automatically.

DBB (Dynamic Bass Boost)

There are three DBB settings to enhance the bass response.

- 1 Press **DBB**.
→ DBB button lights up.
- 2 Adjust the **JOG CONTROL** (or press **DBB** on the remote control repeatedly) to select the desired Dynamic Bass Boost level : BEAT, PUNCH, BLAST or DBB OFF.
→ If "BEAT" is selected, **DBB 1** will appear on the display.
→ If "PUNCH" is selected, **DBB 2** will appear on the display.
→ If "BLAST" is selected, **DBB 3** will appear on the display.
→ If "DBB OFF" is selected, DBB will be deactivated.

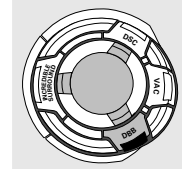

Note:

– Some discs or tapes might be recorded in high modulation, which causes a distortion at high volume. If this occurs, deactivate DBB or reduce the volume.

Automatic DSC-DBB / VAC-DBB selection

The best DBB setting is generated automatically for each DSC or VAC selection. You can manually select the DBB setting that best suits your listening environment.

Incredible Surround

The Incredible Surround magnifies the virtual distance between the front speakers for an incredibly wide, enveloping, stereo effect.

- Press **INCREDIBLE SURROUND** (or **IS** on the remote control) repeatedly to activate/deactivate the surround sound effect.
→ If activated, **INCREDIBLE SURROUND** will appear on the display and the **INCREDIBLE SURROUND** button lights up.
→ If deactivated, "IS OFF" will be displayed.

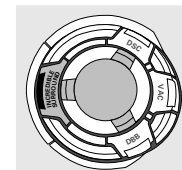



CD/VCD/MP3-CD Operation

English

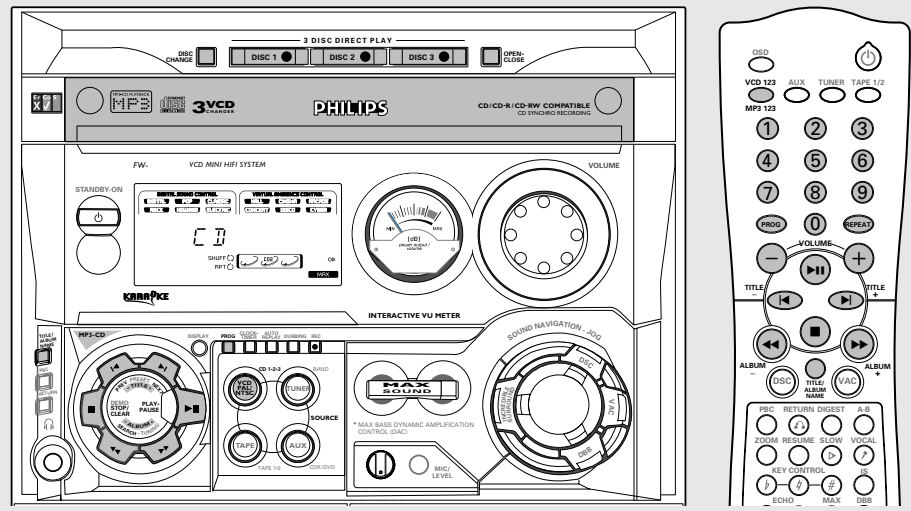

IMPORTANT!

- This system is designed for regular discs. Therefore, do not use any accessories such as disc stabiliser rings or disc treatment sheets, etc., as offered on the market, because they may jam the disc mechanism.
- Do not load more than one disc into the tray.

Before viewing the Video CD, ensure that the set is switched to corresponding PAL or NTSC system of your TV set (exception Multi-system TV).

Discs for Playback

This system can playback all digital audio CD, video CD, MP3-CD format discs, finalised digital audio CD-Recordable (CDR) discs and finalised digital audio CD-Rewritable (CDRW) discs.



Support following MP3-CD formats (ISO9660 format):

- Max. Title/Album name - 30 characters
- Max. Title number plus Album is 255
- Max. nested directory is 8 levels
- The max. Album number is 32
- The max. MP3 programme track number is 99
- Supported VBR bit-rate
- Supported sampling frequencies for MP3 disc : 32 kHz, 44.1 kHz, 48 kHz
- Supported Bit-rates of MP3 disc are: 32, 64, 96, 128, 192, 256 (kbps)

Following formats can't be supported

- The files like *.WMA, *.AAC, *.DLF, *.M3U, *.PLS
- Non English Album/Title name
- The discs recorded under UDF format

Note:

- For mixed mode discs, only one mode will be selected for playback depending on the recording format.



CD/VCD/MP3-CD Operation

Loading Discs

- 1 Press **VCD** to select CD/VCD/MP3-CD mode.
- 2 Press **OPEN•CLOSE** to open the disc tray.
- 3 Load up to two discs on the individual disc trays.
To load the third disc, press **DISC CHANGE**.
→ The disc tray will rotate until the empty tray is ready for loading.

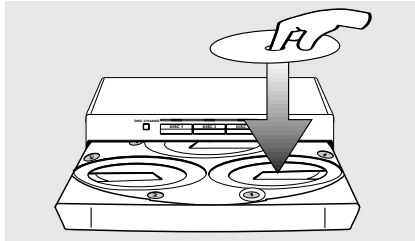

- 4 Press **OPEN•CLOSE** to close the disc tray.
→ "READING DISC" will be displayed. The selected disc, total number of tracks and the playing time will appear on the display.
→ A lighted button indicates that a disc is loaded on the disc tray.

For MP3-CD only

- Load a MP3-CD format music disc on the disc tray.
→ The first album number and first title number "01 1 TOO 1" will be displayed.

Notes:

- Load the discs with the label side facing up.
- To ensure good system performance, wait until the disc tray completely reads the disc(s) before proceeding.
- For MP3-CD, the disc reading time may exceed 10 seconds due to the large number of songs compiled into one disc.

Disc Playback

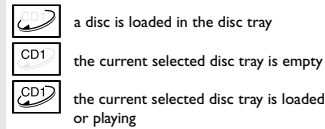

To play all discs on the disc tray

- Press **PLAY ► II**
→ All the available discs will play once, then stop.
→ During playback, the selected disc tray, track number and elapsed playing time of the current track will appear on the display.

To start playback from a selected disc tray

- Press **DISC 1**, **DISC 2** or **DISC 3**.

To interrupt playback

- Press **PAUSE ► II**
- To resume playback, press **PLAY ► II** again.

To stop playback

- Press **■**.

Replace discs during playback

- 1 Press **DISC CHANGE**.
→ "OPEN" will be displayed.
- 2 To change the inner disc, press **DISC CHANGE** again.
→ The active disc will stop playing and the disc tray will close to retrieve the inner disc, then reopen with the inner disc accessible.





CD/VCD/MP3-CD Operation

Select a desired track/passage

To search for a particular passage during playback

- Press ◀ or ▶ to select 4 different search speed.
 - "FRX1"; "FRX2"; "FRX3" or "FRX4" will be displayed on the TV screen when you select a fast rewind search.
 - "FFX1"; "FFX2"; "FFX3" or "FFX4" will be displayed on the TV screen when you select a fast forward search.
 - Normal playback will begin at the end of the fast rewinding or forwarding of the selected track.
- Play returns to normal when **PLAY ▶ II** is pressed or when a new track is selected.

To select a desired track

- Press ◀ or ▶ repeatedly (or **Digits 0-9** on the remote control) until the desired track appears on the display.
- If playback is stopped, press **PLAY ▶ II** to start playback.

Note:

– Maximum track selection from digital keys on the remote control is 199 for MP3-CD and 99 for VCD/CD.

For MP3-CD only

To select a desired Album

- Press **ALBUM -/+** (◀ or ▶) repeatedly until the desired Album appears on the display.
 - **ALB** will start flashing.
 - "RXX TRACK I" will be displayed after the album name scrolled through the display briefly.

To select a desired Title

- Press **TITLE -/+** (◀ or ▶) repeatedly until the desired Title appears on the display.
- Use the digital keys on the remote control to select the track under current Album directly.
 - **TITLE** will start flashing.
 - "R0 I TXXX" will be displayed after the title name scrolled through the display briefly.

Note:

– "R" represents ALBUM and "I" represents TRACK, "XX" or "XXX" is the current selected Album or Track number.

Programming the disc tracks

Programming tracks is possible when playback is stopped. Up to 99 tracks can be stored in the memory in any order.

- 1 Load the desired discs on the disc tray (refer to "Loading Discs").
- 2 Press the **VCD (CD 1•2•3)** button to select the disc tray.
 - Programming can only be done on the selected disc.
- 3 Press **PROG** to start programming.
 - **PROG** will start flashing.
 - It will cancel any previously programmed tracks and selected repeat mode.
- 4 Press ◀ or ▶ repeatedly (or **Digits 0-9** on the remote control) to select the desired track.
 - For MP3-CD, press **ALBUM -/+** and **TITLE -/+** to select the desired Album and Title for programming.
- 5 Press **PROG** to store the track.
 - Repeat **steps 3-5** to store other tracks.
- 6 Press **PLAY ▶ II** to start programme playback.
 - "PLAY PROGRAM" will be displayed.
 - To end programming without starting playback, press **once**.
 - The total number of tracks programmed and the total playing time will appear on the display.

Notes:

- Programme cannot be used for VCDs when PBC is switched on. Switch off PBC before storing tracks.
- For MP3-CD, total playing time will not be shown.
- If the total playing time is more than "99:59", then "- : -" will appear on the display instead of the total playing time.
- If you attempt to programme more than 99 tracks, "PROGRAM FULL" will be displayed.
- During programming, if no button is pressed within 20 seconds, the system will exit the Programme mode automatically.

To review the programme

- Stop playback and press ◀ or ▶ repeatedly.
- To exit review mode, press **once**.



CD/VCD/MP3-CD Operation

To erase the entire programme



- Press **■** **once** when playback is stopped or **twice** during playback.
→ "PROGRAM CLEAR" will be displayed.
→ **PROG** will disappear from the display.

Note:

- *The programme will be erased if you change source, select another disc tray or disconnected the system from the power supply.*

Repeat

You can play the current track/disc/programme repeatedly during playback.

- 1 Press **REPEAT** on the remote control repeatedly to select various repeat modes.
 - **In normal playback**
→ "REPEAT TRACK" – to repeat the current track.
"REPEAT DISC" – to repeat the entire disc.
→ **RPT**  appears on the display.
 - **In programme playback**
→ "REPEAT TRACK" – to repeat the current programmed track.
"REPEAT PROGRAM" – to repeat all programmed tracks.
→ **RPT**  and **PROG** will appear on the display.
 - The current track/disc/programme will now be played repeatedly until you press **■**.
- 2 To resume normal playback, press **REPEAT** until the "REPEAT OFF" mode is displayed.
→ **RPT**  will disappear from the display.

Title/Album Name

This feature use to display the title and album name for MP3-CD.

- Press **TITLE/ALBUM NAME** repeatedly to display the title or album name.
→ **TITLE** will start flashing if title name is displayed.
→ **ALB** will start flashing if album name is displayed.

For Recording, please refer to "Tape Operation/Recording".



CD/VCD/MP3-CD Operation

VIDEO CD

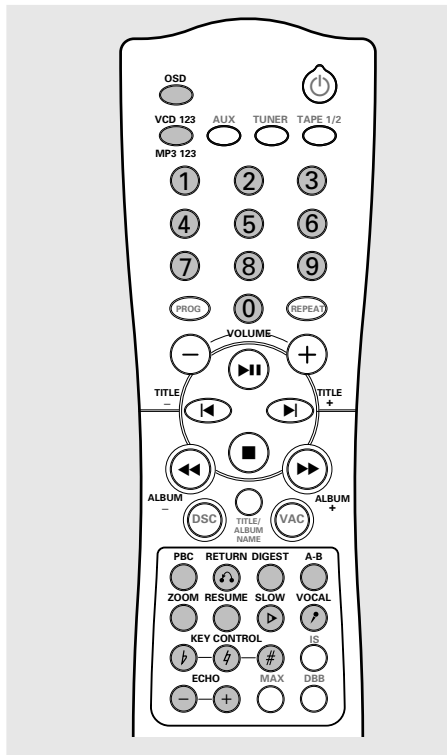

Adjusting the TV System

Before viewing the Video CD, ensure that the set is switched to corresponding PAL or NTSC system of your TV set (except Multi-system TV).

- Press and hold **PAL/NTSC** for more than **2 seconds** to switch between PAL or NTSC TV system.
→ After TV system is selected, the set will automatically switch to the last TV system setting every time the VCD source is selected.

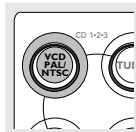

Note:

- Before adjusting the TV system, make sure that there is no MP3-CD in disc tray 1 during power up.

OSD – On Screen Display

If you insert VCD, your TV screen will serve as an additional display for messages (e.g. PLAY, STOP), and information stored on the VCD.

- Press **OSD** on the remote control repeatedly to switch on or off the On Screen Display.

When OSD is switched ON; you can see the following display on the TV screen.

Below is an example of the OSD message.

SINGLE ELAPSED
PLAY XX/TT MM:SS

- "XX" is the current track.
- "TT" is the total tracks.
- "MM" is in minutes.
- "SS" is in seconds.

Note:

- You can also view the information from a MP3-CD or normal CD.

Playing a Video CD with PBC

VCD with PBC (Playback Control) will be indicated on the display of the set as soon as they are inserted. PBC is a predefined play sequence stored on the VCD.

- 1 Switch on the TV, insert a VCD with PBC and press **PLAY ► II** to start playback.
- 2 **MENU** appears on the TV screen.

If the menu consists of a list of titles, you can select a sequence directly

- Press **Digits 0–9** on the remote control to select your choice.
→ The VCD starts playing of the selected sequence automatically.

Note:

- If a menu consists of more than one page, press **◀ / ▶** to go through the pages.

Switching off PBC

- In stop mode, press **PBC**.
→ "PBC OFF" will be displayed.

Notes:

- Programme mode is not available whenever PBC mode is switched on.
- The menu structure depends on the information stored on the VCD. Please refer to the information supplied with the disc.



CD/VCD/MP3-CD Operation

Return

- Press **RETURN** to return to the previous VCD disc MENU level. PBC mode must be switched on.

Digest

This feature allows you to scan through a VCD for a quick review. PBC mode must be switched off. There are four digest mode for selection.

- 1 Press **DIGEST** on the remote control.
 - "DIGEST" appears on the display.
 - "1.INTRO SCAN", "2.DIGEST DISC", "3.DIGEST TRACK" and "4.EXIT DIGEST MENU" appear on the TV screen.

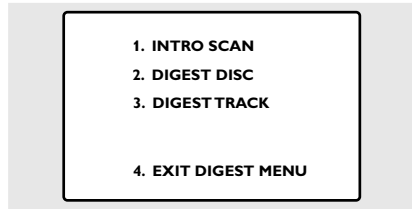

- Press **digit ①** on the remote control to select "INTRO SCAN".
 - The first 10 seconds of each track are played.
- Press **digit ②** on the remote control to select "DIGEST DISC".
 - The first frame of each track appears on the TV screen.
 - Press **digit 0 – 9** on the remote control to playback the desired tracks.
 - Press **◀** or **▶** to view the previous or next page for additional information.
- Press **digit ③** on the remote control to select "DIGEST TRACK".
 - The first track of the selected disc will be divided into 9 parts and displayed on the TV screen.
 - Press **digit 0 – 9** on the remote control to playback the desired parts.
 - Press **◀** or **▶** to digest the next track.
- 2 To exit DIGEST mode, press **digit ④** on the remote control to select "EXIT DIGEST MENU".

A-B Repeat

This feature is also applicable to audio CD (except for MP3-CD). To play a certain scene or passage of the disc repeatedly.

- 1 Press **A-B** on the remote control during playback to mark the start of the chosen scene or passage.
 - "SET A" appears on the display.
- 2 Press **A-B** again to mark the end of the chosen scene or passage.
 - "SET B" appears on the display.
- The selected scene or passage is played repeatedly.
 - "PLAY AB" appears on the display.
- 3 Press **A-B** once more to return to normal playback.
 - "CLEAR AB" appears on the display.

Notes:

- You can also cancel A-B Repeat by pressing **◀** or **▶**.
- You can only able to set the A-B marking within the same track. Once it crosses from one track to the next, the A-B marking is reset.

Zoom

This feature enables you to view a still picture frame in an enlarge mode.

- 1 During playback, press **PAUSE ▶II** to have a still picture on the TV screen.
 - The sound will be muted.
 - On TV screen, "PAUSE" will be displayed.
- 2 Press **ZOOM** on the remote control once to enlarge the still picture by 2 times.
 - "ZOOM" appears on the TV screen.
- You can move the zoomed picture left or right by pressing **◀◀** or **▶▶** respectively.
- You can move the zoom picture down or up by pressing **◀** or **▶** respectively.
- 3 Press **ZOOM** once more to return to normal still frame.
- 4 Press **PLAY ▶II** to continue playback.



CD/VCD/MP3-CD Operation

Resume

This feature is also applicable to audio CD (except for MP3-CD).

- In stop mode, press **RESUME** on the remote control to start playback again from where you have stopped.

Note:

- Resume information is lost if you have changed the disc, opened the disc tray, change source or disconnected the system from the power supply.
- Resume is not available when PBC mode is switched on.

Slow

- 1 Press **SLOW** on the remote control to watch a VCD at a slower speed. There are 3 types of slow modes to select.
 - The sound will be muted.
 - On TV screen, "SLOW 1", "SLOW 2" or "SLOW 3" will be displayed.
- 2 To resume playback at normal speed, press **PLAY ► II**

Vocal

This feature allows you to fade out the original vocal from a karaoke VCD. This feature is used together with Echo mode. You can also use it to select the different audio modes.

- Pressing **VOCAL** on the remote control repeatedly allows you to select the following modes.
 - STEREO → STEREO VOCAL LEFT → STEREO VOCAL RIGHT → MONO LEFT → MONO RIGHT → STEREO ...

STEREO – same effect as the original recorded disc.

STEREO VOCAL LEFT/RIGHT – fade out the original vocal for special recorded Karaoke disc only (with the ECHO mode switched on).



MONO LEFT/RIGHT – select the language on a bilingual VCD.

Ensure that Echo mode is switched on

when press **VOCAL** to fade out the original vocal during STEREO VOCAL LEFT/RIGHT mode.

Key Control (b h #)

This feature allows you to change the key tone of your vocal range.

- Press **b** on the remote control to decrease vocal key level.
 - "KEY -X" and  appears on the display.
- Press **#** on the remote control to increase vocal key level.
 - "KEY +X"  appears on the display.
- Press **h** on the remote control to restore vocal key to original setting.
 - "KEY FLAT" appears on the display.

Note:

- "X" denotes the key level.

Echo

This feature allows you to add echo while singing or talking through a microphone.

- Press **ECHO -/+** on the remote control to decrease, increase or switch off the echo effect.
 - "ECHO -X", "ECHO +X" or "ECHO OFF" appears on the display.

Notes:

- "X" denotes the echo level.
- You are advised to switch off the echo effect when not using the feature.
- If microphone is not inserted, "INSERT MIC" will be displayed.
- Echo will switch off automatically when unplug the microphone from the system.



Radio Reception

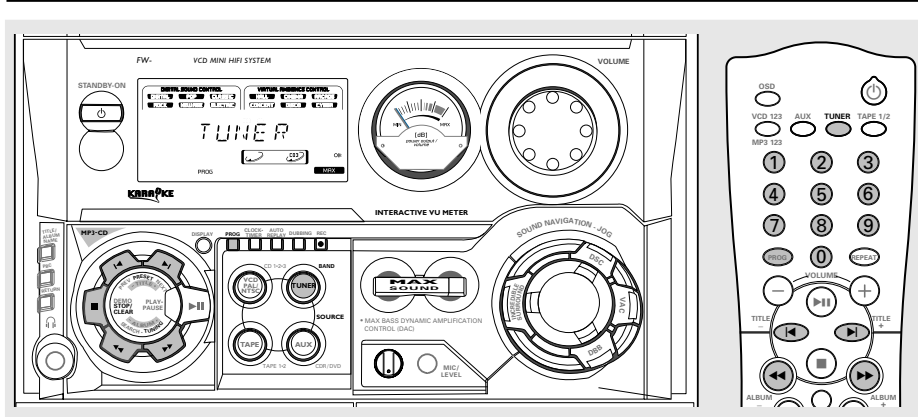

English

Storing Preset Radio Stations

You can store up to 40 preset radio stations in the memory.

Automatic Preset Programming

- Plug and Play setting (refer to "Basic Functions - Plug and Play").

- 1 Press **TUNER** (BAND) to select TUNER mode.
 - "TUNER" will be displayed. A few seconds later, the current radio frequency will appear on the display.
 - If an FM station is received in stereo, will appear on the display.

To begin automatic preset from a desired preset number

- Press or to select the desired preset number.
 - If a radio station has been stored in one of the presets, it will not be stored again under another preset number.
- 2 Press and hold **PROG** until "AUTO" appears on the display.
 - **PROG** will start flashing.
 - The system will start searching for all radio stations on the FM band, then the MW band.
 - All available radio stations with strong signal strength will be stored automatically.
 - The system will stop searching when all the available radio stations are stored or when the memory for 40 preset radio stations is used.
 - The last preset radio station will then be played when completed.

To stop storing the automatic preset

- Press **PROG** or on the system.

Note:

– If no preset number is selected, automatic preset will begin from preset (1) and all your former presets will be overridden.

Manual Preset Programming

- 1 Press **TUNER** (BAND) repeatedly to select the desired waveband : FM or MW.
 - 2 Press **PROG**.
 - **PROG** will start flashing.
 - The next available preset number will be displayed for selection.
 - 3 Press and hold or until the frequency indication starts to change, then release.
 - The display will show "SEARCH" until a radio station with sufficient signal strength is found.
- #### To store the radio station to another preset number
- Press or to select the desired preset number.
- 4 Press **PROG** again to store the radio station.
 - **PROG** will disappear from the display.
- Repeat **steps 2–4** to store other preset radio stations.

Tuning to a weak radio station

- Press or briefly and repeatedly until the optimal reception is found.

To stop storing the manual preset

- Press on the system.





Radio Reception

Notes:

- If you attempt to store more than 40 preset radio stations, "PROGRAM FULL" will be displayed.
- During programming, if no button is pressed within 20 seconds, the system will exit the Programme mode automatically.

Tuning to Preset Radio Stations

- Once you've preset the radio stations, press ◀ or ▶ to select the desired preset number.
 - The preset number, radio frequency, and waveband will appear on the display.

Erasing a Preset Radio Station

- 1 Press ◀ or ▶ to select the preset radio station to be erased.
 - 2 Press and hold ■ on the system until "PRESET DELETED" appears on the display.
 - The radio frequency remain on the display.
 - The preset numbers of all other preset radio stations in the band with higher numbers are also decreased by one.
- Repeat **steps 1–2** to erase other preset radio stations.

Changing Tuning Grid

In some countries, the frequency step between adjacent channels in the MW band is 10 kHz (9 kHz in some areas). The preset frequency step in the factory is 9 kHz.

Changing the tuning grid will erase all previously stored preset radio stations.

- 1 Disconnect the system from the AC power supply (pull out the AC power cord).
- 2 While holding down **TUNER** and ▶▶ on the system, reconnect the system to the AC power supply.
 - The display will show "GRID 9" or "GRID 10".

Notes:

- GRID 9 and GRID 10 indicate that the tuning grid is in step of 9 kHz and 10 kHz respectively.
- The FM tuning grid also will be changed from 50 kHz to 100 kHz or vice versa.

For Recording, please refer to "Tape Operation/Recording".



Tape Operation/Recording

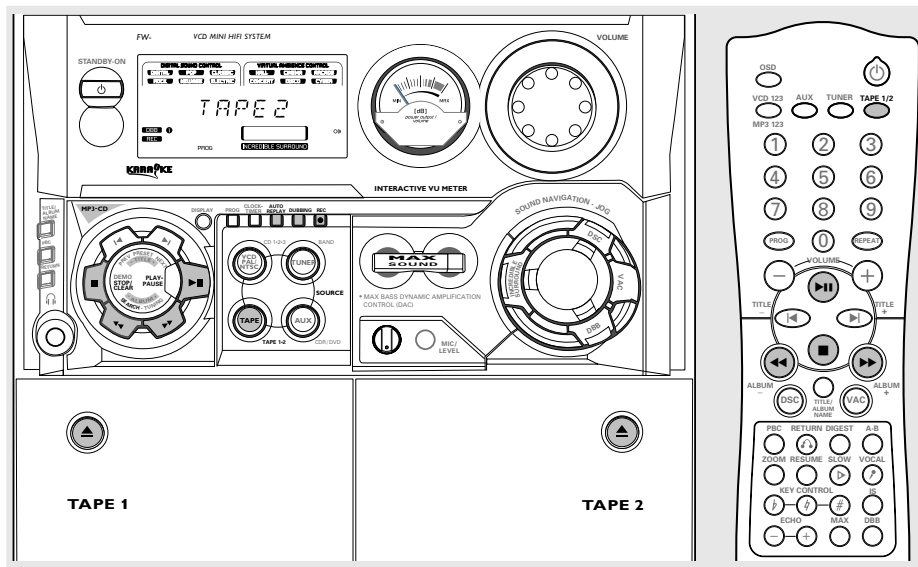

English

IMPORTANT!

- Before playing a tape, check and tighten slack tape with a pencil. Slack tape may get jammed or may burst in the mechanism.
- C-120 tape is extremely thin and is easily deformed or damaged. It is not recommended for use in this system.
- Store the tapes at room temperature and do not put them too close to a magnetic field (for example, a transformer, TV or speaker).

Tape Playback

- 1 Press to open the tape deck door.
- 2 Insert a recorded tape and close the tape door.
- Load the tape with the open side down and the full spool to the left.
- 3 Press **TAPE** (TAPE 1•2) repeatedly to select tape deck 1 or tape deck 2.
→ The selected tape deck number is displayed.
- 4 Press **PLAY** to start playback.

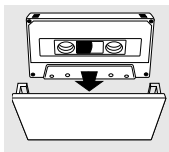

To stop playback

- Press .

To change the playback mode

- Press **AUTO REPLAY** repeatedly to select the different playback modes.
→ "AUTO REPLAY" (∞) or "ONCE" will appear on the display.

AUTO REPLAY ...the tape will rewind automatically at the end of playback and replay again. It will replay up to a maximum of 20 times or until you press .

ONCEthe tape will playback the selected side once and then stop.

To rewind or fast forward when playback is stopped

- 1 Press or .
- 2 Press when you reached the desired passage.

To reset tape counter number

- When in stop mode, press .
- "T 1 000" or "T 2 000" will be displayed.

Notes:

- The tape counter will automatically set to zero after detecting end of tape.



Tape Operation/Recording

General Information on Recording

- If you do not intend to record via the microphone, unplug the microphone to avoid accidental mixing with other recording source.
- For recording, use only tape of IEC type I (normal tape).
- The recording level is set automatically, regardless of the position of the Volume, VAC, DSC and so forth.
- The tape is secured at both ends with leader tape. At the beginning and end of the tape, nothing will be recorded for six to seven seconds.
- To prevent accidental recording, break out the tab on the left shoulder of the tape side you want to protect.

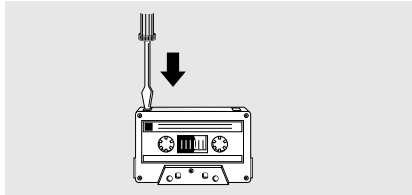

- If "CHECK TAPE" is displayed, the protection tab has been broken. Put a piece of clear adhesive tape over the opening.

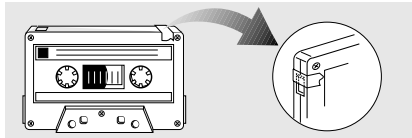

IMPORTANT!

- Recording is permissible if copyright or other rights of third parties are not infringed upon.
- Recording is possible only on tape deck 2.

Preparation for Recording

- 1 Press **TAPE** (TAPE 1•2) to select TAPE 2.
- 2 Load a recordable tape into tape deck 2 with full spool to the left.
- 3 Prepare the source to be recorded.
 - VCD** – load the disc(s).
 - TUNER** – tune to the desired radio station.
 - TAPE** – load the prerecorded tape into tape deck 1 with the full spool to the left.
 - AUX** – connect external equipment.

When recording is in progress

- **REC** starts flashing.
- It is not possible to listen to another sources except when dubbing tapes.
- It is not possible to activate the timer function.

One Touch Recording/Recording the mixed sound

- 1 Press **VCD**, **TUNER** or **AUX** to select the source.
- You can connect a microphone to record the mixed sound in tape deck 2 (refer to "Karaoke - Microphone Mixing").
- 2 Start playback of the selected source.
- 3 Press **REC** to start recording.

To stop recording

- Press **■** on the system.

Note:

- One Touch Recording is not possible in TAPE mode, "SELECT SOURCE" will be displayed.

CD/VCD/MP3-CD Synchro Recording

- 1 Press **VCD** to select the disc.
- Press **◀** or **▶** to select the desired track to start recording.
- You can programme the tracks in the order you want them to be recorded (refer to "CD/VCD/MP3-CD Operation - Programming the disc tracks").
- 2 Press **REC** to start recording.
 - The disc will start playback automatically.



Tape Operation/Recording

To select another track during recording

- 1 Press **PAUSE ►||** to interrupt recording.
- 2 Press **◀** or **▶** to select the desired track.
- 3 Press **PLAY ►||** to resume recording.

To stop recording

- Press **■**.
→ Recording and disc playback will stop simultaneously.

To stop dubbing

- Press **■**.

Notes:

- Dubbing of tapes is possible only from tape deck 1 to tape deck 2.
- To ensure good dubbing, use tapes of the same length.
- You can listen to another source while dubbing.

Dubbing Tapes

- 1 Load the prerecorded tape in tape deck 1.
- You can set the tape to the desired passage where recording will start.
- 2 Press **DUBBING**.
→ Playing and recording will start simultaneously.
→ "BBB 000" will be displayed.
- Dubbing of tapes is possible on one side of the tape only. To continue recording on the reverse side, at the end of side A, flip the tapes to side B and repeat the procedure.

Karaoke

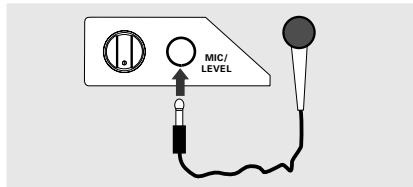

Microphone Mixing

Connect a microphone (not supplied) to the system allowing you to sing along with the music source.

- 1 Connect a microphone to the MIC jack.
- Before connecting the microphone, set the microphone **LEVEL** to the minimum level to prevent howling sound.
- 2 Press **VCD, TUNER, TAPE** or **AUX** to select the source to be mixed and start playback.

- 3 Adjust the volume level of the source with **VOLUME** control.
- 4 Adjust the microphone volume with microphone **LEVEL** control.

Note:

- Keep the microphone away from the speakers to prevent howling.

For Recording, please refer to "Tape Operation/Recording".



Clock/Timer

English

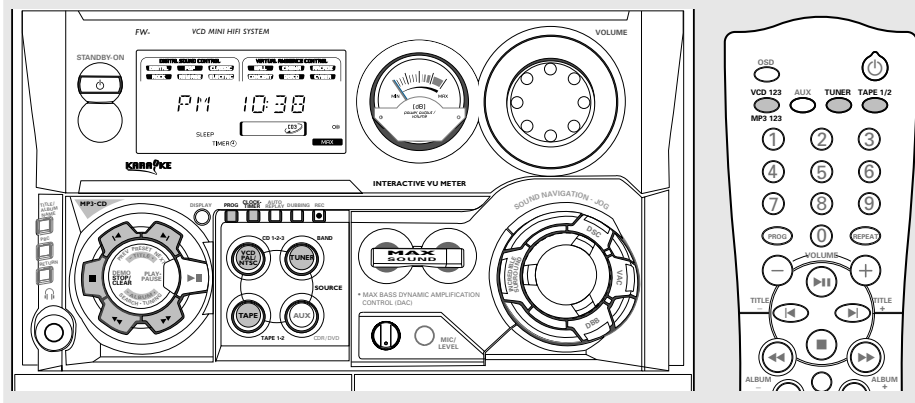

View Clock

The clock (if it is set) will be shown in Standby mode.

To view the clock in any source mode (VCD or TUNER for example)

- Press **CLOCK-TIMER**.
 - The clock will be displayed for a few seconds.
 - If the clock has not been set, "----:--" will be displayed.

Clock Setting

The clock can be set in either 12-hour or 24-hour mode ("PM 12:00" or "00:00" for example)

- 1 Press **CLOCK-TIMER** twice.
- 2 Press **PROG** on the system repeatedly to select clock mode.
 - If 12-hour mode is selected, "PM 12:00" will start flashing.
 - If 24-hour mode is selected, "00:00" will start flashing.
- 3 Press **◀** or **▶** on the system repeatedly to set the hour.
- 4 Press **◀** or **▶** on the system repeatedly to set the minute.
- 5 Press **CLOCK-TIMER** again to store the setting.
 - The clock will start working.

To exit without storing the setting

- Press **■** on the system.

Notes:

- The clock setting will be cancelled when the power cord is disconnected or if a power failure occurs.
- During clock setting, if no button is pressed within 90 seconds, the system will exit clock setting mode automatically.

Timer Setting

The system can switch on to VCD, TUNER, or TAPE 2 mode automatically at a preset time, serving as an alarm to wake you up.

IMPORTANT!

- Before setting the timer, ensure that the clock is set correctly.
- The timer will always be switched on after it has been set.
- The timer will not start if a recording is in progress.
- The volume of the timer will increase gradually from the minimum level to the last tuned volume level.

- 1 Press and hold **CLOCK-TIMER** for more than two seconds to select timer mode.
 - "PM 12:00" or "00:00" or the last timer setting will start flashing.
 - **TIMER** will start flashing.
 - The selected source will be lighted while other available sources are flashing.
- 2 Press **VCD**, **TUNER** or **TAPE** to select the desired source.



Clock/Timer

- Before setting the timer, make sure the music source has been prepared.
VCD – Load the disc(s). To start from a specific track, make a programme (refer to "CD/VCD/MP3-CD Operation - Programming the disc tracks").
TUNER – tune to the desired radio station.
TAPE – load the prerecorded tape into tape deck 2.
- 3 Press ◀ or ▶ on the system repeatedly to set the hour for the timer to start.
- 4 Press ◀ or ▶ on the system repeatedly to set the minute for the timer to start.
- 5 Press **CLOCK•TIMER** to store the start time.
 → "TIMER ON" will be displayed and followed by the set timer "X:X:X" and then the selected source.
 → **TIMER** will remain on the display.
- At the preset time, the selected source will play.

To exit without storing the setting

- Press ■ on the system.

To deactivate the TIMER

- 1 Press and hold **CLOCK•TIMER** for more than **two seconds**.
- 2 Press ■ on the system to cancel the timer.
 → The display will show "CANCEL" and **TIMER** will disappear from the display.

To activate the TIMER (for the same preset time and source)

- 1 Press and hold **CLOCK•TIMER** for more than **two seconds**.
- 2 Press **CLOCK•TIMER** again to store the start time.
 → The last set timer information will be shown for a few seconds and **TIMER** will appear on the display.

Notes:

- If the source selected is VCD, playback will begin with the first track of the last selected disc or other trays if disc is empty. If all the disc trays are empty, TUNER will be selected instead.
- During timer setting, if no button is pressed within 90 seconds, the system will exit timer setting mode automatically.

External Sources

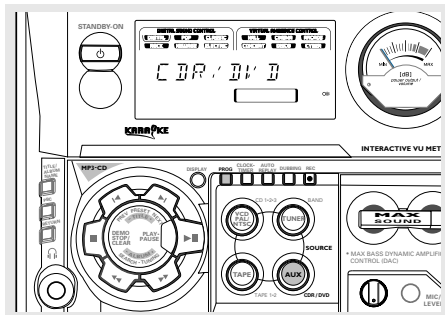

Listening to External Sources

- 1 Connect the audio out terminals of the external equipment (TV, VCR, Laser Disc player; DVD player or CD Recorder) to the AUX/CDR IN terminals of your system.

- 2 Press **AUX** (CDR/DVD) repeatedly to select CDR/DVD mode or normal AUX mode.
 → "CDR/DVD" or "AUX" will be displayed.
- If the sound from the external source is distorted, select CDR/DVD mode for listening.

Notes:

- You are advised not to listen to and record from the same source simultaneously.
- All the navigation sound control features (DSC or VAC for example) are available for selection.
- Refer to the operating instructions for the connected equipment for details.

For Recording, please refer to "Tape Operation/Recording".



Specifications

AMPLIFIER

Output power 2200 W PMPO
 2 x 60 W RMS⁽¹⁾
 Signal-to-noise ratio ≥ 75 dBA (IEC)
 Frequency response 50 – 20000 Hz, ± 3 dB
 Input sensitivity
 AUX In / CDR/DVD In 500 mV / 1V
 Microphone 3.5 mV
 Output
 Speakers $\geq 6 \Omega$
 Headphones $32 \Omega - 1000 \Omega$
 (1) (6 Ω , 1 kHz, 10% THD)

DISC PLAYER

Number of programmable tracks 99
 Frequency response 20 – 20000 Hz
 Signal-to-noise ratio ≥ 76 dBA
 Channel separation ≥ 79 dB (1 kHz)
 Total harmonic distortion $< 0.02\%$ (1 kHz)
 MPEG 1 VCD version 2.0
 MPEG 1 Layer 3 (MP3-CD) MPEG AUDIO
 MP3-CD bit rate 32 – 256 kbps
 sampling frequencies ... 48 kHz, 44.1 kHz, 32 kHz

TUNER

FM wave range 87.5 – 108 MHz
 MW wave range (9 kHz) 531 – 1602 kHz
 MW wave range (10 kHz) 530 – 1700 kHz
 Tuning grid 9/10 kHz
 Number of presets 40
 Antenna
 FM 75 Ω wire
 AM Loop antenna

TAPE PLAYER

Frequency response
 Normal tape (type I) 80 – 10000 Hz (8 dB)
 Signal-to-noise ratio
 Normal tape (type I) ≥ 48 dBA
 Wow and flutter $\leq 0.4\%$ DIN

SPEAKERS

Front left/right

System 3-way; Bass reflex
 Impedance 6 Ω
 Woofer 1 x 5.25"
 Tweeter 1 x 2"
 Polydome Tweeter 1 x 1"
 Dimensions (w x h x d) . 240 x 310 x 290 (mm)
 Weight 3.85 kg each

GENERAL

Material/finish Polystyrene/Metal
 AC Power 110 – 127 / 220 – 240 V;
 50/60 Hz Switchable
 Power Consumption
 Active 120 W
 Standby 15 W
 Dimensions (w x h x d) .. 265 x 310 x 390 (mm)
 Weight (without speakers) 7.5 kg

Specifications and external appearance are subject to change without notice.



Maintenance

Cleaning the Cabinet

- Use a soft cloth slightly moistened with a mild detergent solution. Do not use a solution containing alcohol, spirits, ammonia or abrasives.

Cleaning Discs

- When a disc becomes dirty, clean it with a cleaning cloth. Wipe the disc from the centre out. Do not wipe in circular motion.
- Do not use solvents such as benzine, thinner, commercially available cleaners, or antistatic spray intended for analogue records.



Cleaning the disc lens

- After prolonged use, dirt or dust may accumulate at the disc lens. To ensure good playback quality, clean the disc lens with Philips CD Lens Cleaner or any commercially available cleaner. Follow the instructions supplied with cleaner.

Cleaning the Heads and the Tape Paths

- To ensure good recording and playback quality, clean the heads (A), the capstan(s) (B), and pressure roller(s) (C) after every 50 hours of tape operation.
- Use a cotton swab slightly moistened with cleaning fluid or alcohol.
- You also can clean the heads by playing a cleaning tape once.

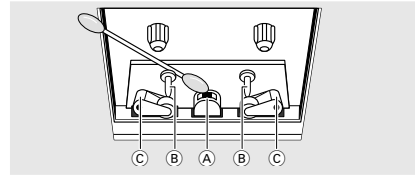

Demagnetising the heads

- Use a demagnetising tape available at your dealer.

Troubleshooting

WARNING

Under no circumstances should you try to repair the system yourself, as this will invalidate the warranty. Do not open the system as there is a risk of electric shock.

If a fault occurs, first check the points listed below before taking the system for repair. If you are unable to remedy a problem by following these hints, consult your dealer or service centre.

Problem	Solution
DISC PLAYER OPERATION	
"UNREADABLE DISC" is displayed.	<ul style="list-style-type: none"> – Check if the disc is inserted upside down. – Wait until the moisture condensation at the lens has cleared. – Replace or clean the disc, see "Maintenance". – Use a readable disc or correct recorded format MP3-CD.
"NO DISC" is displayed.	<ul style="list-style-type: none"> – Insert a disc.
No picture on TV screen.	<ul style="list-style-type: none"> – Connect the cable between the system and TV.
No colour on TV.	<ul style="list-style-type: none"> – Change the system to the respective PAL or NTSC setting.
Cannot adjust the TV system to PAL or NTSC.	<ul style="list-style-type: none"> – Remove the MP-3 CD from disc tray 1 or press DISC CHANGE twice to select a non MP3 disc tray



English

Troubleshooting

RADIO RECEPTION

Radio reception is poor.

- If the signal is too weak, adjust the antenna or connect an external antenna for better reception.
- Increase the distance between the Mini HiFi System and your TV or VCR.

TAPE OPERATION/RECORDING

Recording or playback cannot be made.

- Clean deck parts, see "Maintenance".
- Use only NORMAL (IEC I) tape.
- Apply a piece of adhesive tape over the missing tab space.

The tape deck door cannot open.

- Remove and reconnect the AC power plug and switch on the system again.

GENERAL

The system does not react when buttons are pressed.

- Remove and reconnect the AC power plug and switch on the system again.

Sound cannot be heard or is of poor quality.

- Adjust the volume.
- Disconnect the headphones.
- Check that the speakers are connected correctly.
- Check if the stripped speaker wire is clamped.
- Make sure the MP3-CD was recorded within 32-256 kbps bit rate with sampling frequencies at 48 kHz, 44.1 kHz or 32 kHz.

The left and right sound outputs are reversed.

- Check the speaker connections and location.

The remote control does not function properly.

- Select the source (VCD or TUNER, for example) before pressing the function button (▶, ◀, ▶).
- Reduce the distance between the remote control and the system.
- Insert the batteries with their polarities (+/- signs) aligned as indicated.
- Replace the batteries.
- Point the remote control directly toward IR sensor on the front of the system.

The timer is not working.

- Set the clock correctly.
- If a recording is in progress, stop the recording.

Not all lighted buttons are showing light.

- Press DISPLAY to select NORMAL or MODE 1 display mode.

The Clock/Timer setting is erased.

- Power has been interrupted or the power cord has been disconnected. Reset the clock/timer.

The system displays features automatically and buttons start flashing.

- Press and hold DEMO STOP ■ on the system to switch off the demonstration.



Meet Philips at the Internet
<http://www.philips.com>

English

中文

Bahasa Melayu

Bahasa Indonesia

FW-V520



3139 115 21901

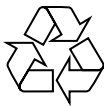

SL-0134/21-4